

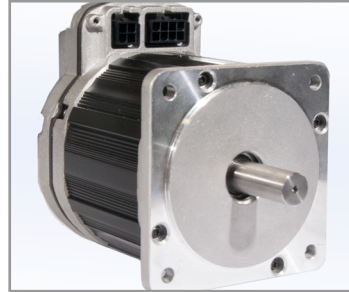

Maximum Flexibility, Made Affordable

MultiCam heard the industry challenge and has built the first fully capable, turnkey CNC solution at an affordable price! This rigid and reliable servo driven machine has four spindle options and either a single or dual tangential knife option. Both the spindle and knife are perfectly suited to cut a multitude of materials with unsurpassed performance and cut quality.



Servo Drive System Smooth & Accurate

The Apex1R, comes standard with a Robust Drive Motor system with Servo Drives to allow for powerful yet fluid motion.

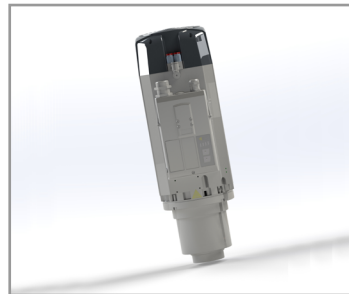

Router Spindle Multiple Spindle Options Up To 10HP

The Apex1R comes equipped with a high-frequency spindle for optimal durability when cutting thin or dense materials.



Base Frame Solid Heavy-Duty Construction

A solid-steel frame design is standard on the Apex1R. It provides a heavy and accurate platform that translates into gentle motion for clean, smooth cuts.



Linear ATC Automatic Tool Changer

The Apex1R with ATC spindle offers a linear rack for spindle tool holder pickup. Automatic spindle tool pickup rack is a high value yet low cost option.



Helical Rack Smooth Motion, Minimal Friction

Helical racks are standard on the Apex1R and provide smooth and accurate motion as the gantry moves through all axes.

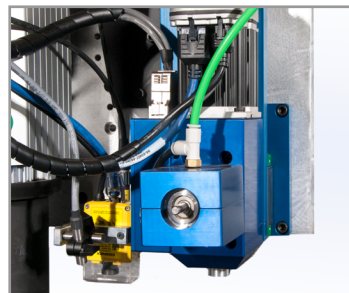

Tangential Knives Enhanced Cutting Capabilities

The single or dual knife system expands the cutting capabilities of the Apex1R by allowing a wide range of materials to cut with electric oscillating or the quick change drag knife attachments.



Gantry Custom Engineered for Maximum Rigidity

MultiCam engineered the gantry from steel tube that is precisely machined for maximum rigidity at the spindle tool, providing users with optimum edge quality.



4 Zone Vacuum Work Surface Manual or Pneumatic Valves

Optimize vacuum hold down using 4 zones to your standard work surface of 1" thick 80-82 Durometer phenolic gridded top. User friendly pneumatic valves enhances operator workflow by saving time.



EZ Control

Powerful, Intuitive Control

MultiCam's EZ Control provides all users, from novice to advanced, with the most powerful and easy-to-use control system available on today's market. New operators can be productive in as little as an hour!



Coreo Software

Workflow Management

The Apex 1R comes with Coreo machine interface software. Upgradeable to an easy CAD/CAM suite designed to efficiently streamline workflow.

Options:

MultiVision

Laser Pointer

Mister

Barcode Scanner

Multiple Quick Change Knife Holders

Dust Collection System



MultiVision

Dynamic Digital Registration

MultiVision provides additional flexibility by visually recognizing media registration marks and automatically compensating for skew and image drift.

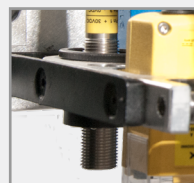

Laser Pointer

Decrease Job Set-Up Times

Quickly and accurately identify reference points on the material to minimize job set-up time.

Specifications	Inches	Metric
Max Material Thickness	3"	76.2mm
Repeatability	+/-0.001"	+/-0.025mm
Cutting Speed	1300 IPM	550.33 mm/sec
Rapid Traverse	1900 IPM	804.3 mm/sec
Drive System (X,Y)	Helical	Helical
Drive System (Z)	Ball Screw	Ball Screw
Standard Work Surface	1" Phenolic	25.4mm Phenolic

Model	Inches	Metric
103	48" x 96"	1219mm x 2438mm
204	60" x 120"	1524mm x 3048mm
304	83" x 121"	2108mm x 3073mm

*Other sizes available

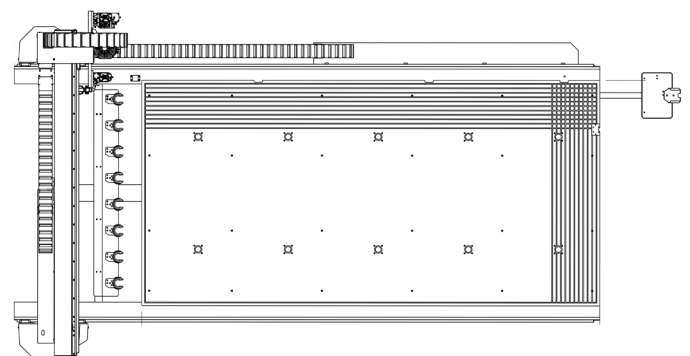
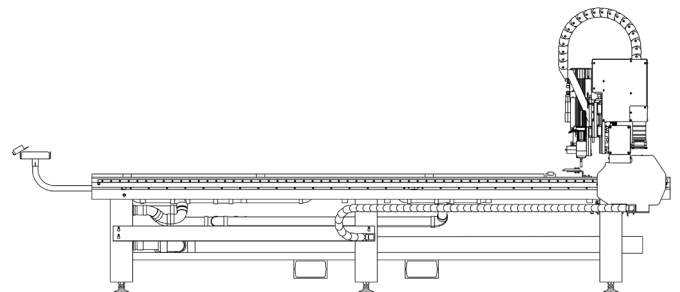
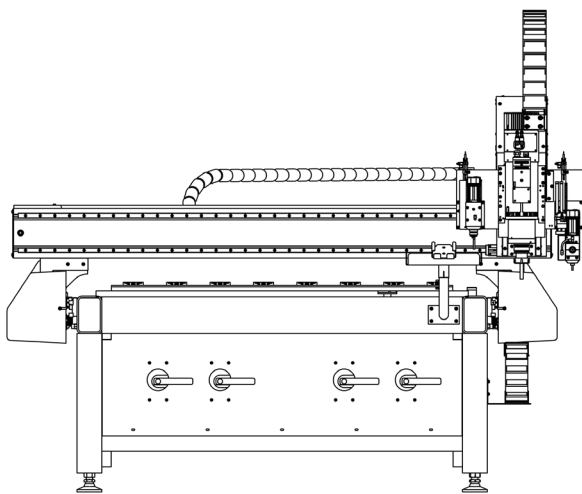

For Tooling & Consumables visit MultiCamTooling.com

