

TALEXconverter LCU 60W 12/24V IP67 TOP
Outdoor IP67 series

Product description

- Constant voltage LED power supply
- Universal input voltage range
- Constant output voltage
- Connection: Cable with end sleeves (length approx. 500 mm)
- Polarity identifiers, secondary + red / – black
- Metal casing, encapsulated
- Nominal life-time up to 50,000 h (at ta 50 °C with a failure rate max. 0.2 % per 1,000 h)
- 5-year guarantee
- Suitable for emergency installations according to EN 50172
- Complies with CLASS C from minimum to maximum load range according to EN 61000-3-2



Properties

- Small design
- High efficiency
- Low power loss
- Overtemperature and overload protection
- Short-circuit shutdown feature with automatic restart
- SELV
- Type of protection IP67
- Metal casing



IP67 SELV Class 2 

TALEXconverter LCU 60W 12/24V IP67 TOP
Outdoor IP67 series

Technical data

Rated supply voltage ²	100 – 277 V
Input voltage, AC ²	90 – 305 V
Input voltage, DC	176 – 288 V
Rated current (at 230 V, 50 Hz, full load)	0.32 A
Mains frequency	0 / 50 / 60 Hz
Efficiency (at 230 V, 50 Hz, full load)	> 85 %
λ (at 230 V, 50 Hz, full load)	0.95
Output voltage tolerance 12 V	-0 / +10 %
Output voltage tolerance 24 V	-0 / +5 %
Output power (ta ≤ 60 °C)	60 W
Output power (ta > 60 °C)	48 W
Output power range	6 – 60 W
Turn on time (output)	≤ 0.5 s
Turn off time (output)	≤ 1 s
Hold on time at power failure (Output)	10 ms
Ambient temperature ta	-40 ... +70°C
Ambient temperature ta (at life-time 50,000 h)	-40 ... +50 °C
Storage temperature ts	-40 ... +85 °C
Dimensions LxWxH	240 x 40 x 21 mm
Hole spacing	232 x 18 mm

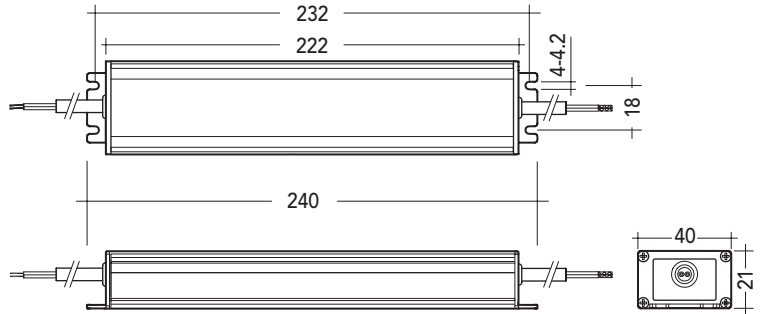

Ordering data

Type	Article number	Packaging carton	Packaging pallet	Weight per pc.
LCU 60W 12V IP67 TOP	28000509	10 pc(s).	480 pc(s).	0.45 kg
LCU 60W 24V IP67 TOP	28000512	10 pc(s).	480 pc(s).	0.45 kg

Specific technical data

Type	Max. casing temperature tc	Output voltage	Max. input power	Output current range	Max. output voltage ¹
LCU 60W 12V IP67 TOP	90 °C	12 V	74 W	0.50 – 5.0 A	13.2 V
LCU 60W 24V IP67 TOP	90 °C	24 V	74 W	0.25 – 2.5 A	25.2 V

¹ At failure mode (230 V, 50 Hz).

² 90 – 108 V AC: ta ≤ 60 °C: max. load = 48 W, ta > 60 °C: max. load = 38 W.

Standards

EN 55015
EN 60598-1
EN 60598-2-22
EN 61000-3-2
EN 61000-3-3
EN 61347-1
EN 61347-2-13
EN 61547
EN 62384
EN 62493
Acc. to EN 50172: suitabel for central battery systems

Overload protection

Automatic shutdown of the LED Driver if the maximum output current is exceeded. Automatic restart if the output current is below the limit.

No-load operation

The LED Driver is not damaged in no-load operation. The max. output voltage (see page1) can be obtained during no-load operation.

Over temperature protection

Automatic power reduction of the LED Driver if the temperature limit is exceeded. Automatic restart to nominal mode if the temperature falls below the limit.

Short-circuit behaviour

In case of a short circuit on the secondary side (LED) the LED Driver switches into hiccup mode. After the removal of the short-circuit fault the LED Driver will recover automatically.

Expected life-time

Type	Output voltage	ta	40 °C	50 °C	60 °C
LCU 60W 12V IP67 TOP	12 V	tc	65 °C	75 °C	85 °C
		Life-time	> 100,000 h	> 50,000 h	> 25,000 h
		tc	65 °C	75 °C	85 °C
LCU 60W 24V IP67 TOP	12 V	Life-time	> 100,000 h	> 50,000 h	> 25,000 h

Maximum loading of automatic circuit breakers

Automatic circuit breaker type	C10	C13	C16	C20	B10	B13	B16	B20	Inrush current	
Installation Ø	1.5 mm ²	1.5 mm ²	1.5 mm ²	2.5 mm ²	1.5 mm ²	1.5 mm ²	1.5 mm ²	2.5 mm ²	I _{max}	time
LCU 60W 12V IP67 TOP	14	18	22	28	8	10	13	16	47 A	95 µs
LCU 60W 24V IP67 TOP	14	18	22	28	8	10	13	16	47 A	95 µs

Harmonic distortion in the mains supply (at 230 V / 50 Hz and full load) in %

Type	THD	3	5	7	9	11
LCU 60W 12V IP67 TOP	10	2	1	2	1	1
LCU 60W 24V IP67 TOP	10	2	1	2	1	1

Wiring diagram

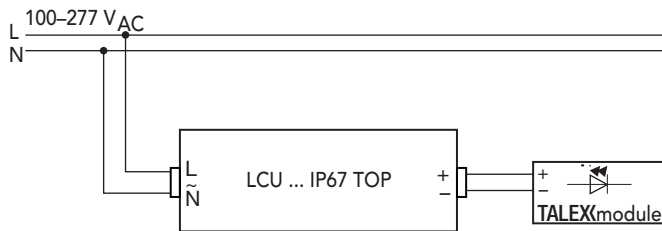

Installation instructions

The switching of LEDs on secondary side is not permitted. A proper functioning of the LCU in combination with third party dimming devices (e.g. PWM) cannot be guaranteed.

Connection

Primary cable		Secondary cable	
L	N	+	-
brown	blue	red	black

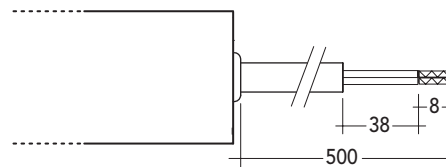

PRI:

Ø 7.7 ± 0.2 mm; 2 x 1.04 mm² (17 AWG)

SEC:

Ø 7.7 ± 0.2 mm; 2 x 1.04 mm² (17 AWG)

Isolation and electric strength testing of luminaires

Electronic devices can be damaged by high voltage. This has to be considered during the routine testing of the luminaires in production.

According to IEC 60598-1 Annex Q (informative only!) or ENEC 303-Annex A, each luminaire should be submitted to an isolation test with 500VDC for 1 second. This test voltage should be connected between the interconnected phase and neutral terminals and the earth terminal. The isolation resistance must be at least 2 MΩ.

As an alternative, IEC 60598-1 Annex Q describes a test of the electrical strength with 1500 V AC (or 1.414 x 1500 V DC). To avoid damage to the electronic devices this test must not be conducted.

Diagrams for 12 V

Efficiency vs load

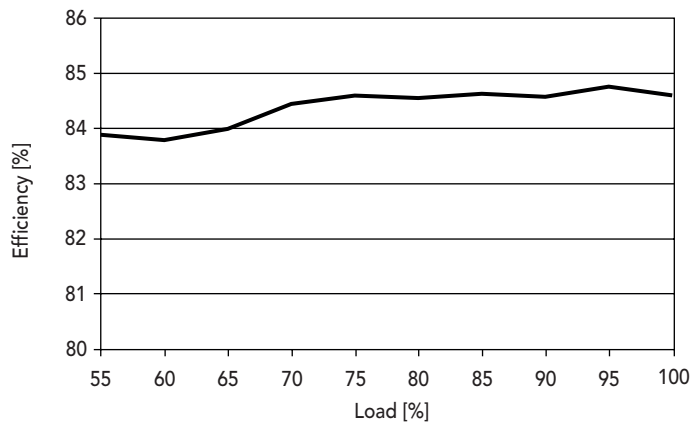

Power factor vs load

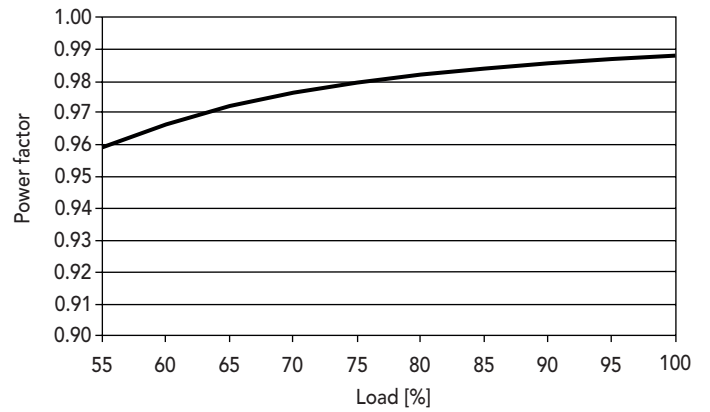

THD vs load

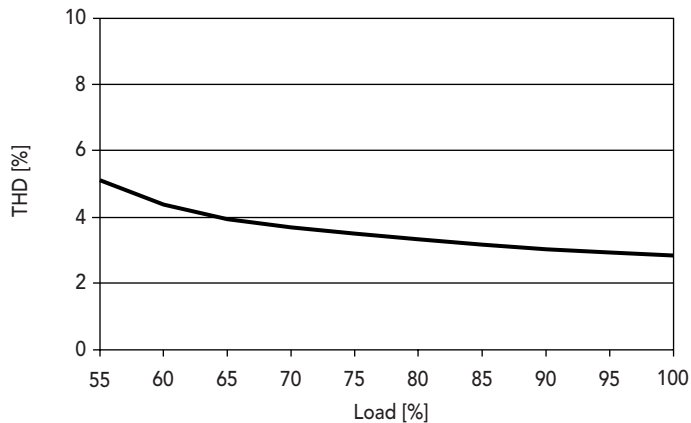

Diagrams for 24 V

Efficiency vs load

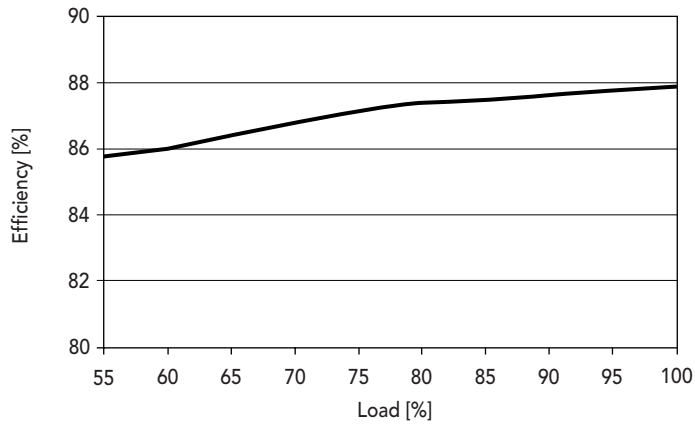

Power factor vs load

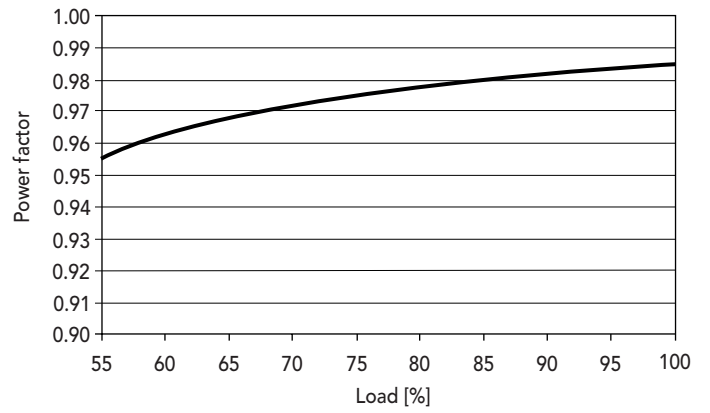

THD vs load

