



■ STRIEBIG ■

[WWW.STRIEBIG.COM](http://WWW.STRIEBIG.COM)

COMPACT  
STANDARD  
STANDARD S  
EVOLUTION  
CONTROL  
STRIEBIG 4D

# VERTICAL SAW TECHNOLOGY

VERSATILE. PRECISE. SOLID.

# VERSATILE. PRECISE. SOLID.

STRIEBIG - THE ECONOMICAL CUTTING TECHNOLOGY!



The Swiss label is a symbol of quality, safety, reliability and solidity.

We share and live these values for our customers.



Vertical structure – our head office in Lucerne.

## INNOVATION COMPETENCE

For over five decades, we have been concentrating on a single product category: vertical panel saws. Ludwig Striebig, the founder of our company, invented this technology.

With passion and comprehensive expertise, we create long-lasting value for you: STRIEBIG is synonymous with vertical panel saws.

**Saw a wide range of panel materials with efficiency and precision.**

## STRIEBIG SAW VERTICAL SAW

### THE SAW FRAME

Free-standing, fully welded and torsion-resistant, it ensures many years of cutting precision and a high degree of investment security.

### THE SAW BEAM

Its steel structure is especially stable and long-lasting. The double interlocking ensures absolute angle accuracy, ensuring cutting precision for many, many saw cuts.

### THE SAW UNIT

The unit's robust mounting and powerful drive guide it smoothly and ensure easy and precise operation.

## THE "SIZING CUT" PRINCIPLE

PRECISE DIMENSIONS,  
PERFECTLY CUT AND  
READY TO GLUE.

**Every STRIEBIG ensures glue-ready edges without any reworking, with a precision of 1/10 mm. For us, exact edges are the measure of all things.**

Utilise the consulting services of our sales partners, and discover the diversity of our solutions.

## VERSATILITY

This catalogue gives an overview of our product range. Configure your perfect saw at [www.striebig.com](http://www.striebig.com).

At our specialist dealership partners, you can find STRIEBIG solutions for vertical cutting technology in the showroom. Utilise their consulting services, and select your individual STRIEBIG.

## CUTTING OPTIMISATION, OPTIONS AND ACCESSORIES

- p. 16 OptiDivide, retrofittable cutting optimisation
- p. 16 BaseCut CON, cutting optimisation 'Light'
- p. 17 ExpertCut CON, cutting optimisation 'Professional'
- p. 17 POP 4D, panel optimisation program
- p. 18 Options for manually guided saws
- p. 19 Options for automatically guided saws
- p. 20 Accessories for manually guided saws
- p. 21 Accessories for automatically guided saws
- p. 22 Technical data

### COMPACT

Flexible entry-level saw

p. 4



### STANDARD

Proven universal saw

p. 6



### STANDARD S

Flexible universal saw

p. 8



### EVOLUTION

Entry-level automatic saw

p. 10



### CONTROL

Premium automatic saw

p. 12



### STRIEBIG 4D

Automatic high-end saw centre

p. 14

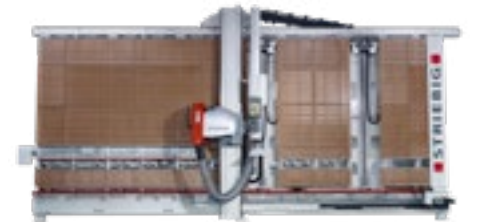



# COMPACT

## FLEXIBLE ENTRY-LEVEL SAW

### FUNCTION AND BENEFITS

IMPRESSIVE IN EVERY DETAIL



### SUPPORT ROLLERS

Up to 17 support rollers.



### NEATLY SOLVED

The cable chain ensures durability. It keeps the hose lines and cables separate.

### THE SAW UNIT

**Robust mounting,  
powerful drive.**

The motor: strong and high-torque, 3.9 kW.

The guide: backlash-free and smooth.

In combination with the robust mounting of the saw unit, this ensures simple and precise working. Series standard cutting depth 60 mm.



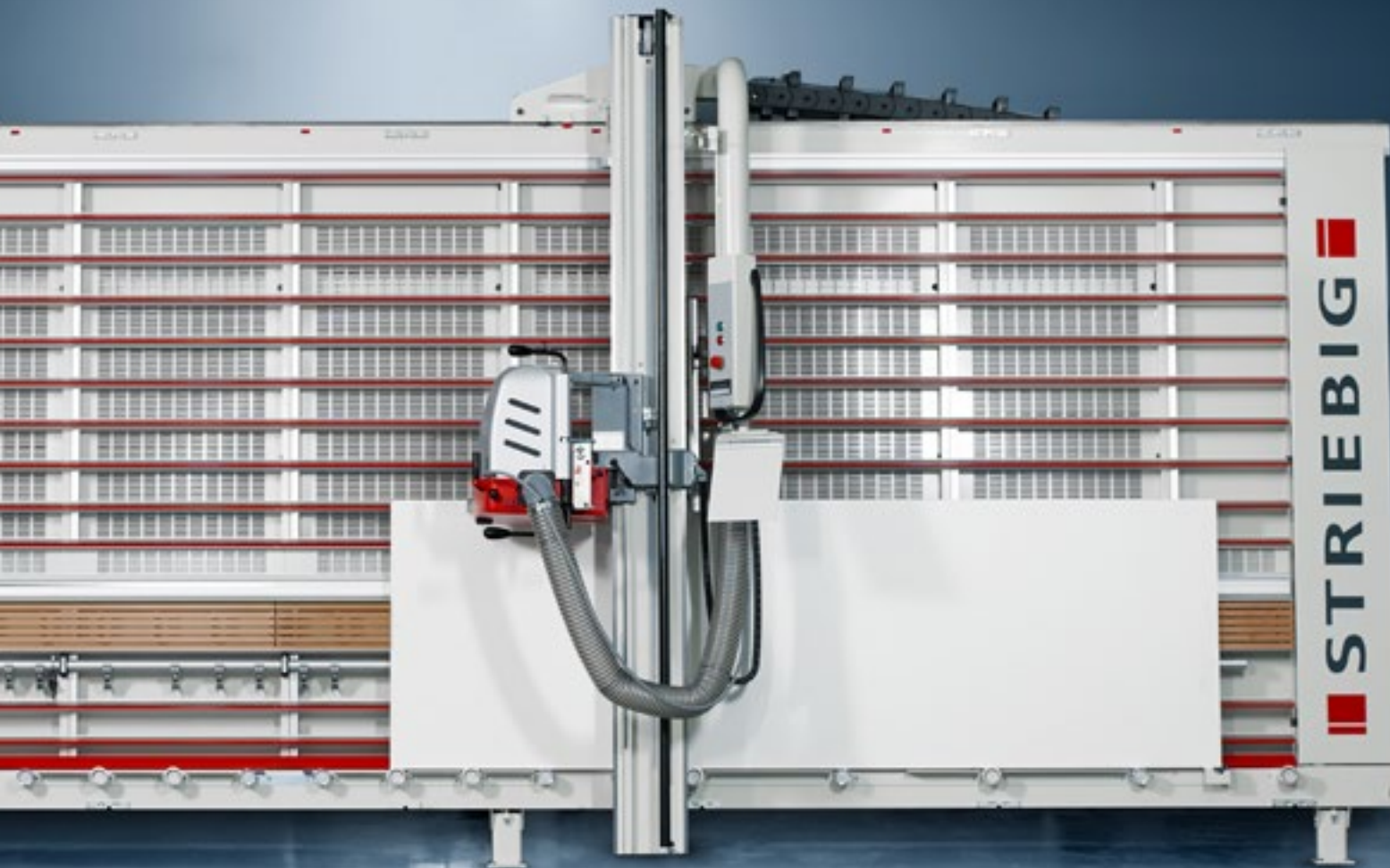

**MECHANICALLY BRAKED  
SUPPORT ROLLER (OPTION)**



**VSA PRE-SCORING UNIT**

Saves time, costs and tools. For larger quantities, for potentially lower quality panels and for coated panel materials, the VSA (accessory) is a must.



**DMS-X – DIGITAL MEASURING SYSTEM**

Always the right size. DMS for the X axis (accessory).  
Freely selectable display precision between 1.0/0.5 and 0.1 mm.



# STANDARD

## PROVEN UNIVERSAL SAW



Ergonomically designed: STANDARD beam, control box and saw motor (5.5 kW).  
The double locking saw beam ensures absolute angular accuracy.  
The standard cutting depth is 80 mm.

## IT RUNS AND RUNS AND RUNS

Tried-and-tested over decades and considered as the VW Beetle of the vertical panel saw sector: the Striebig STANDARD.

The STANDARD has been the benchmark in universal vertical sawing for years. Its flexibility and expansion options make it the ideal panel saw for companies of all sizes.

## UNIVERSAL FOR DIVERSE APPLICATIONS

Universal in its standard equipment. The built-in strip cutting gauge makes repeat cuts easier while the fixed dimension setting ensures reliable operation for recurring dimensions.

Universal in its design.

We offer the STANDARD in two different versions:

- TRK1 with a flat support wall made of birch plywood
- TRK2 with automatically yielding aluminium support frame with plastic supports



Striebig STANDARD TRK2



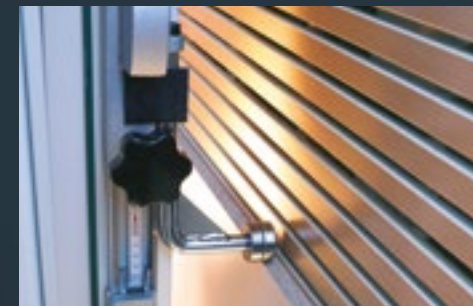
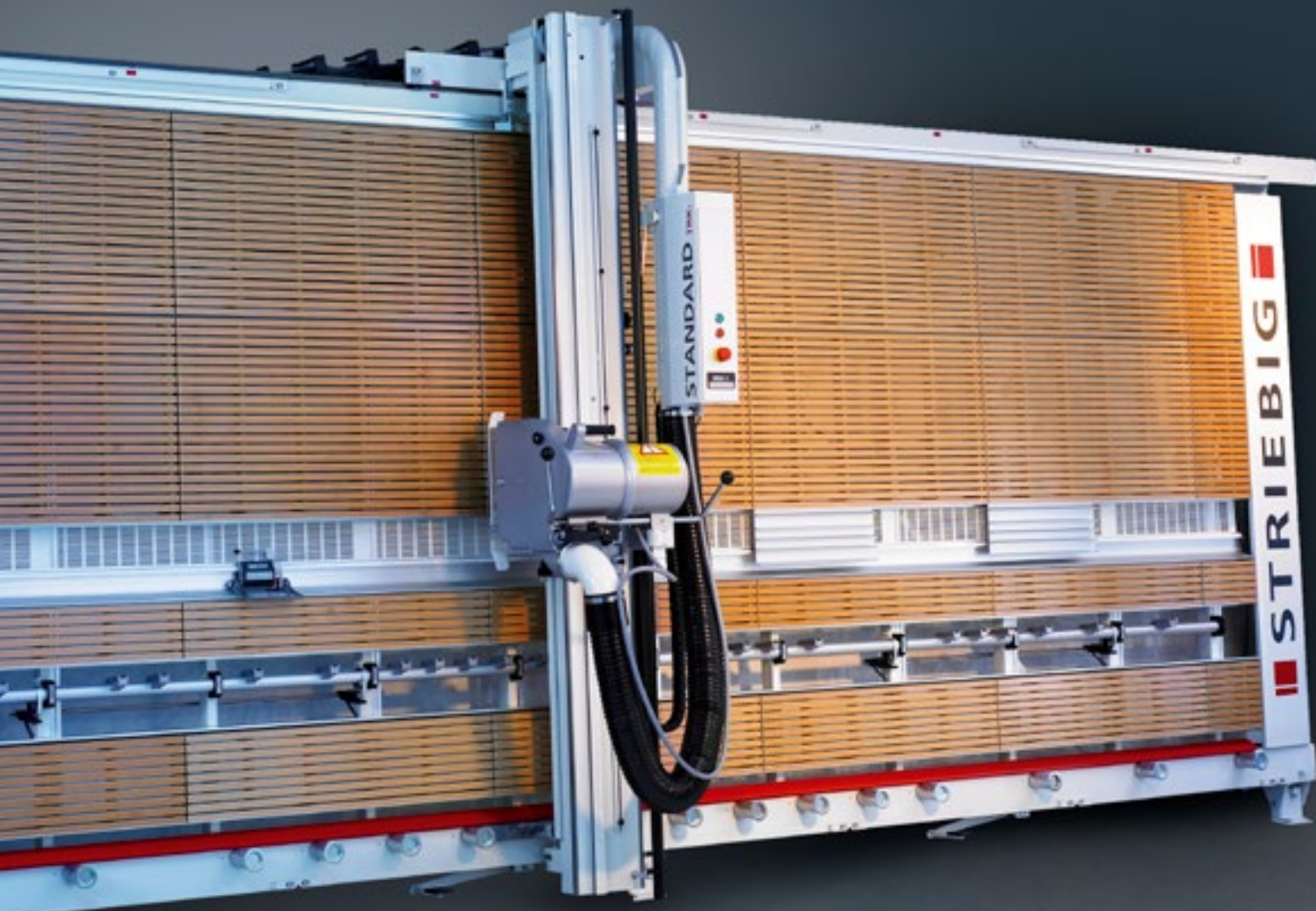

### STRIP CUTTING GAUGE

The standard strip cutting gauge with edge-protecting roller support makes repeat cuts easier.



### PAPER HOLDER - DOCUMENTS ALWAYS WITHIN REACH (ACCESSORIES)

Keeps the work documents available right beside the control box.



### DMS - DIGITAL MEASURING SYSTEM

Always the right size. DMS for the X axis (accessory). Freely selectable display precision between 1.0/0.5 and 0.1 mm.



# STANDARD S

## FLEXIBLE UNIVERSAL SAW

The STRIEBIG STANDARD - the world's best-selling vertical panel saw.

The STANDARD S is the new addition to the success story. It combines proven and new technology. With two versions, TRK1 and TRK2, and the recommended features with the attractive Comfort package, it offers a variety of options.

STANDARD S - EQUIPMENT TRK1 / TRK2	TRK1	TRK2	TRK1	TRK2
	Comfort	Comfort		
Saw frame, saw beam saw unit	S	S	S	S
TRK dust extraction	S	S	S	S
Strip cutting gauge	S	S	S	S
Automatically yielding wooden support wall	S	-	S	-
Automatically yielding aluminium slatted frame	-	S	-	S
Roller support with 17 rollers and 3 brake pedals	-	-	S	S
Device for wall mounting	S	S	S	S
Strip gutting gauge for repeat cuts	S	S	S	S
Program cam follower for recurring dimensions	S	S	S	S
Small parts support made of aluminium	○	S / ○	○	S / ○
Small parts support made of wood	S	○	S	○
Pneumatic clamping saw unit	S	S	-	-
Digital measuring system vertical (Y) axis, incl. motorized fine adjustment	S	S	-	-
Pneumatically braked support rollers	S	S	-	-
Laser indicator for horizontal cuts	S	S	○	○

S = Series · ○ = Option (can only be ordered from the factory)

### RECOMMENDED: THE COMFORT PACKAGE

- Pneumatic clamping saw unit
- Digital measuring system vertical (Y) axis
- Pneumatically braked support rollers
- Laser indicator for horizontal cuts



#### DIGITAL MEASURING SYSTEM VERTICAL

Motorised fine adjustment of the Y axis at the touch of a button. (Standard equipment for the Comfort package)



#### LASER INDICATOR

Pin-point accuracy. Laser indicator for horizontal cuts

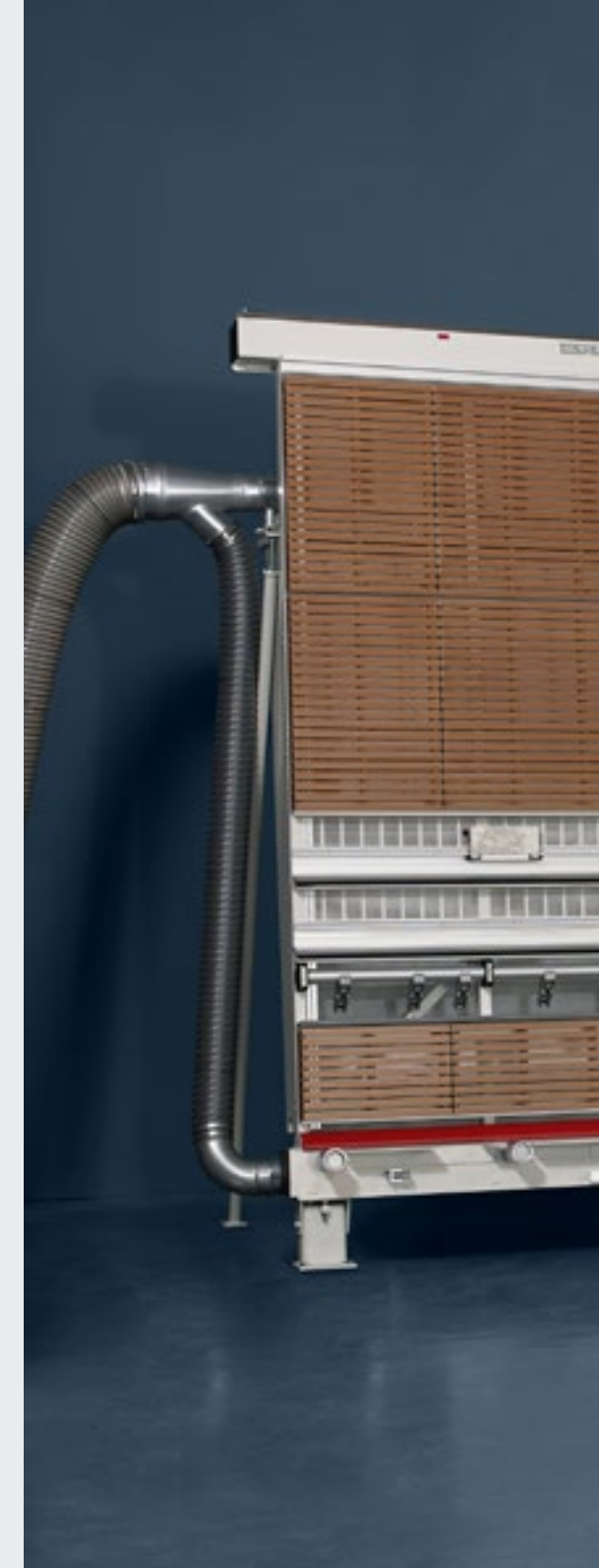





STANDARD S TRK1 Comfort –Fig. includes optional equipment



### THE SAW UNIT

Strong, powerful motor with 5.5 kW. 80 mm cutting depth as standard. The guide: backlash-free and smooth.



### VSA PRE-SCORING UNIT

Saves time, costs and tools. For larger quantities, for potentially lower quality panels and for coated panel materials, the VSA (accessory) is a must.

STANDARD S - TRK2 – Fig. includes optional equipment

# EVOLUTION

## ENTRY-LEVEL AUTOMATIC SAW



Easier for the operator: automatic locking and swivelling and automatic plunge and withdrawal of the saw unit.

**ALWAYS A GOOD DECISION -**  
PRECISION, ERGONOMICS AND FUNCTIONALITY  
PERFECTLY COMBINED

Automatic functions, such as automatic locking and swivelling or automatic plunge and withdrawal of the saw unit make your daily work easier. The standard cutting depth is 80 mm.

EVOLUTION is operated via a 12" touch screen computer. The installed software ensures ease of use in every aspect.

## COMPREHENSIVE STANDARD EQUIPMENT

- 12" inch touch screen computer with optimal user guidance
- Laser indicator for horizontal cuts
- Digital measuring system DMS (both axes)
- Automatic saw blade lock with interface recognition
- Automatic locking and swivelling of the saw unit
- Automatic plunge and withdrawal of the saw unit
- Automatic fine adjustment of the saw unit
- Operating hour counter
- Tool database
- ALU central support over entire machine length
- Integrated, powerful TRK dust extraction system. Dust limit of around 1 mg/m<sup>3</sup>
- Control cabinet attached directly to the saw frame (separate installation not required)
- Super silent sound insulation

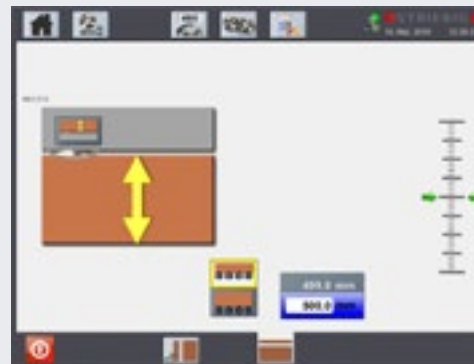

Automatic fine adjustment of the saw unit position for horizontal cuts. Measurement from the support rollers and for strip cutting







#### LASER INDICATOR

Pin-point accuracy. Laser-supported horizontal cut indicator.



#### DMS - DIGITAL MEASURING SYSTEM

Always the right size. DMS for the X axis (accessory). Freely selectable display precision between 1.0/0.5 and 0.1 mm.

# CONTROL

## PREMIUM AUTOMATIC SAW



Automatic motorised tilting is just one of the many functions that support fully automatic sawing with the CONTROL. Standard cutting depth: 80 mm.

### CONTROL -

#### INTELLIGENT AND ERGONOMICALLY DESIGNED CUTTING TECHNOLOGY

The 12" touch screen computer and new machine software ensure improved operating convenience in every detail. Advanced equipment and innovative vertical 4.0 options allow a high level of automation in the sawing process and the integration of the CONTROL into the operational data flow.

### VERTICAL 4.0

#### IMPROVED AUTOMATIC CUTTING

The intelligent visualisation on the touch screen guides the operator through the cutting plan step by step.

#### STRIEBIG ExpertCut CON THE 'PROFESSIONAL' VERSION.

Import parts lists from standard ERP or CAD systems and optimise the cutting layout with the ExpertCut software on the production planning workstation.

### MORE EQUIPMENT MORE USES

- 12" inch touch screen computer with optimal user guidance
- Laser indicator for horizontal cuts
- Digital measuring system DMS-X
- Electronic positioning system EPS.y incl. automatic top trimming - ABO
- Automatic saw blade lock with interface recognition
- Automatic locking and swivelling of the saw unit
- Automatic plunge and withdrawal of the saw unit
- Automatic panel end detection
- Fully automatic sawing process
- Selectable sawing cycle
- Pneumatic coupling for easy conversion to manual operation
- Operating hour counter
- Tool database
- ALU central support over entire machine length
- Integrated, powerful TRK dust extraction system. Dust limit of around 1 mg/m<sup>3</sup>
- Super silent sound insulation
- Network connection'

#### STRIEBIG BaseCut CON THE 'LIGHT' VERSION.

Create simple parts lists and optimise the cutting automatically and easily with the 12" touch screen panel of your STRIEBIG CONTROL.

For details about BaseCut CON / ExpertCut CON, see pages 16 and 17.

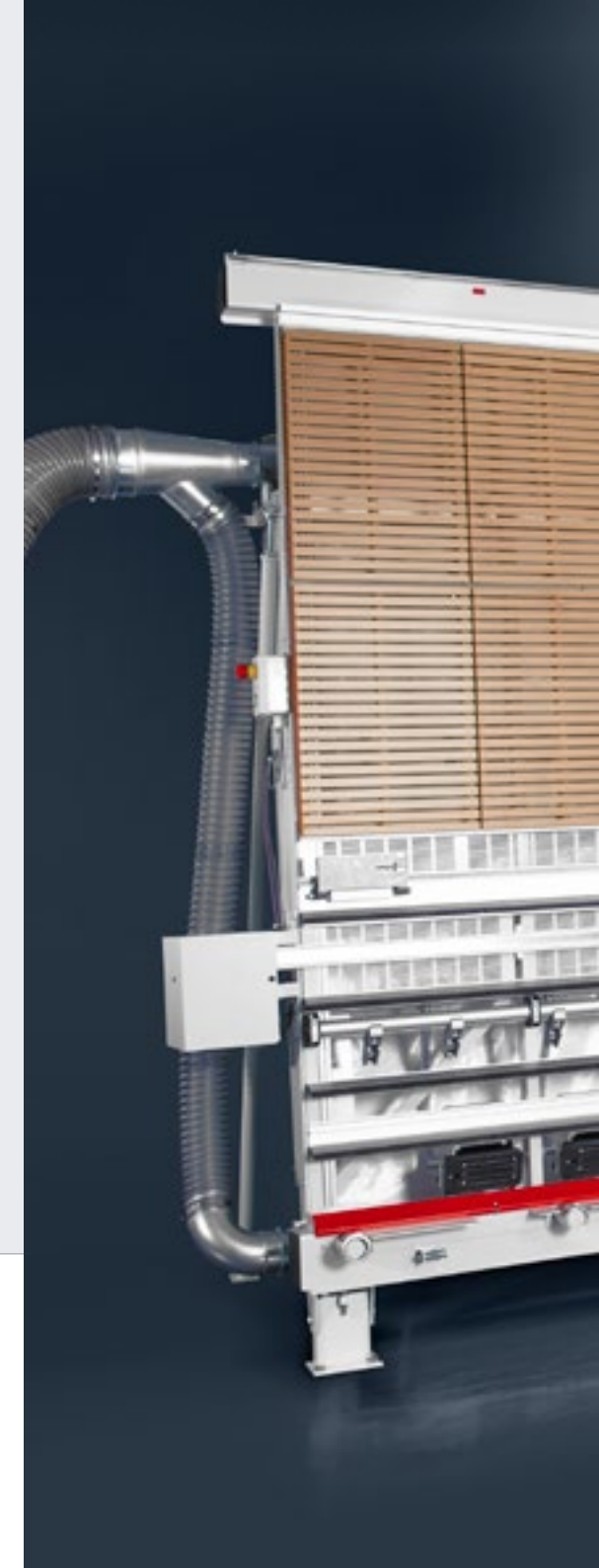





#### **ABO - TOP TRIMMING / EPS.Y**

With the standard EPS.y you automatically position the saw unit for the horizontal saw cut. The standard ABO ensures the automatically running upper trimming cut. This combination can be supplemented with the 4SB (option) for the lower trimming cut.



#### **4SB - LOWER TRIMMING (OPTION)**

The lower trim cut becomes child's play: Panels up to 5300mm long and 2185mm high can be trimmed automatically by the 4SB system. This eliminates the need for heavy physical work.

#### **NEW, OPTIMISED CONTROL CENTRE**

With the logically structured STRIEBIG-HMI you can control the CONTROL very easily and conveniently with the 12" touch screen.



# STRIEBIG 4D

## AUTOMATIC HIGH-END SAW CENTRE



Almost effortless - 1-man operation of the 4D (Fig. includes optional equipment)

### STRIEBIG 4D - SPACE AND TIME IN PERFECT SYMBIOSIS

A Striebig 4D is always a tailor-made solution for your company. Customisation is the order of the day. The entire horizontal and vertical transport of the workpiece (optional) through the Striebig 4D is fully automatic. Comfortable, almost effortless 1-man operation of the saw becomes standard.

### VERTICAL 4.0 POP 4D - THE PANEL OPTIMISATION PROGRAM

**The 4D offers you intelligent cutting optimisation for your requirements.**

The program provides an automatic cutting order, optimum sawing process and the best possible material utilisation.

We can adjust interfaces to meet the requirements of your PPS system. We program them to your liking and adapt them perfectly to the POP 4D.

Further details about the POP 4D can be found on page 17.

### HIGH-END WITH PERFECT BASIC EQUIPMENT

- 12" touch screen computer with optimal user guidance
- Laser indicator for horizontal cuts
- Digital measuring system DMS-X
- Electronic positioning system for horizontal section EPS.y
- Automatic saw blade lock with interface recognition
- Automatic swivelling of the saw unit in vertical or horizontal cutting position
- Automatic plunge and withdrawall of the saw unit
- Automatic panel end detection
- Automatic movement of the splitting wedge
- Continuously adjustable feed rate 10-25 m / min
- Selectable sawing cycle
- Pneumatic coupling for easy conversion to manual operation
- Operating hour counter
- Tool database
- ALU central support over entire machine length
- ProLock Easy-Fix tool clamping system
- Light field monitors the 4D danger zone and ensures a high level of safety during operation
- Integrated, powerful TRK dust extraction system. Dust limit of around 1 mg/m<sup>3</sup>
- Super silent sound insulation





### EXTENDED CUTTING DEPTH

80 mm cutting depth as standard.  
EST105 (105 mm) or EST130 (130 mm)  
cut depths are possible with the 4D. (Optional)



### PAV - FULLY AUTOMATIC PANEL LOWERING DEVICE

The coated PAV clamps are also designed for sensitive surfaces. Even heavy panels are firmly held. (Optional)

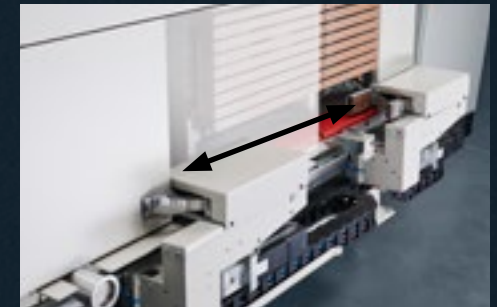

### PPS - FULLY AUTOMATIC PROGRAMMABLE PANEL SLIDER

The PPS unit positions the panel horizontally with precision. (Optional)

### VSA PRE-SCORING UNIT

Saves time, costs and tools. For larger quantities, for potentially lower quality panels and for coated panel materials, the VSA (accessory) is a must.

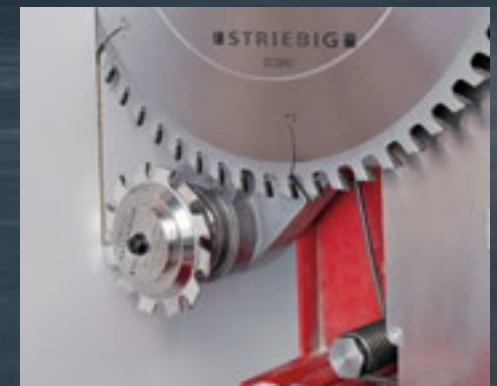

# VERTICAL 4.0

## IMPROVED AUTOMATIC CUTTING

### OPTIDIVIDE

#### THE RETROFITTABLE VERSION

**Easy to operate, efficient in use and easy to retrofit: OptiDivide provides greater automation in panel cutting. The system works independently of the machine control. Many STRIEBIG models can be retrofitted.**

OptiDivide takes parts lists from customary ERP or CAD systems. The visualisation on the touch screen directly on the saw guides the operator through the individual work flow.

The operator acknowledges the executed work steps on the touch screen. As soon as it is cut, the label printer prints the identification label for the cut element. Step by step, you can work through even complex cuts efficiently.



#### DELIVERY

- Compact aluminium housing (WxHxD = 320 x 372 x 322 mm) integrated: 12" touch screen computer incl. stylus, label printer
- Network connection via (WIFI)
- Software package STRIEBIG-cut optimisation, incl. 1 network license for office workstation
- Power cable, mounting adapter for the corresponding STRIEBIG model, operating instructions (including installation description)

#### RETROFITTABLE FOR

- STRIEBIG COMPACT (from year of construction 2004)
- STRIEBIG STANDARD (from year of construction 2005)
- STRIEBIG STANDARD S
- STRIEBIG EVOLUTION / CONTROL (from year of construction 2001)

### EXPERTCUT CON / BASECUT CON

#### CUTTING OPTIMISATION (OPTIONS FOR THE CONTROL FROM YEAR OF CONSTRUCTION 2018)

#### BaseCut CON

##### The ,LIGHT' VERSION FOR THE CONTROL

**You create simple parts lists and optimise the cutting automatically and easily with the 12" touch screen panel of your CONTROL. The intelligent visualisation on the touch screen guides the operator through the cut step by step.**

The operator positions the saw unit and the length stop (EPS.x) with the START key.

The CONTROL drives the defined mass automatically. As soon as it is cut, the label printer prints the identification label for the cut element.

Cut by cut, the CONTROL works through the optimised cutting plan. STRIEBIG BaseCut CON can be used with or without the automatic trimming option 4SB.

#### DELIVERY PACKAGE

- Electronic positioning system EPS.x
- Automatic saw beam positioning ASP
- Software package (user guide with STRIEBIG ExpertCut CON or BaseCut CON), label printer
- Connection option for network connection via LAN (WIFI can be extended by the customer)
- Only ExpertCut CON: 1 office workstation (network license), user manual



BaseCut CON Cutting plan visualisation



BaseCut CON Execution of the cutting plan



### ExpertCut CON

#### THE ‚PROFESSIONAL‘ VERSION FOR THE CONTROL

Import parts lists from standard ERP or CAD systems and optimise the cutting layout with the ExpertCut software on the production planning workstation. With the program you can also edit and manage order, material and parts lists.

You transfer the cutting plan directly to the CONTROL. The intelligent visualisation on the 12” touch screen panel of your CONTROL guides the operator step by step through the cutting process.

The operator positions the saw unit and the length stop (EPS.x) with the START key. The CONTROL drives the defined dimension automatically. As soon as it is cut, the label printer prints the identification label for the cut element. Cut by cut, the CONTROL works through the optimised cutting plan. STRIEBIG ExpertCut CON can be used with or without the automatic trimming option 4SB.

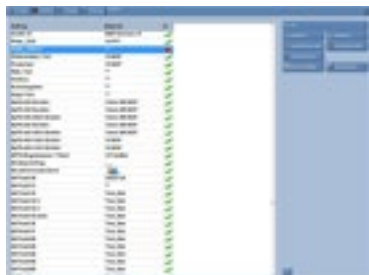

ExpertCut CON Cutting plan

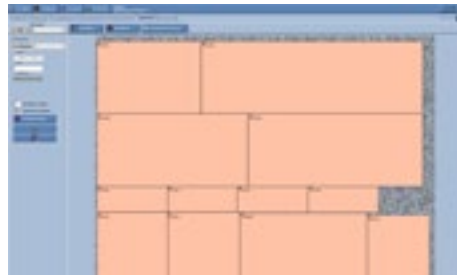

ExpertCut CON Order list



### POP 4D

#### THE PANEL OPTIMISATION PROGRAM

POP 4D - the intelligent cutting optimisation for the STRIEBIG 4D ensures an automatic cutting sequence, optimum sawing process and the best possible material utilisation.

We can adjust interfaces to meet the requirements of your PPS system. We program them to your liking and adapt them perfectly to the POP 4D.

#### Import of cutting plans

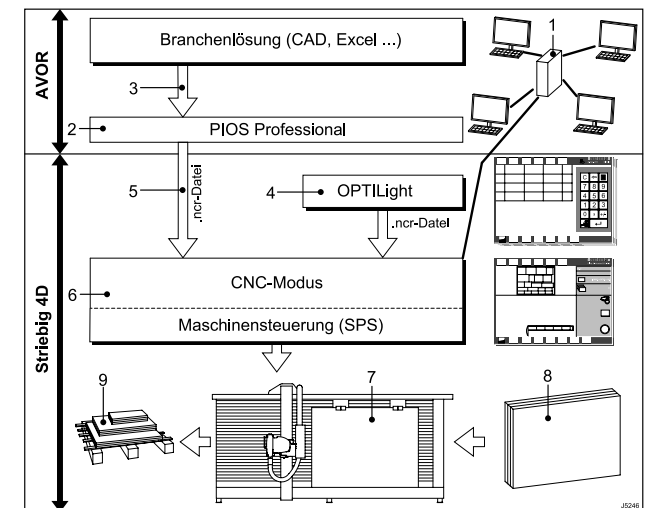

1. Network with industry software
2. PIOS Professional (software)
3. Data export from industry software
4. OPTILight
5. .NCR file import in 4D
6. 4D (CNC mode / machine control)
7. 4D sawing centre / panel cutting
8. Raw formats
9. Blanks

# OPTIONS

FOR OUR MANUAL SAWS

For your STRIEBIG, we offer you a wealth of options to complement or expand the benefits and applications.

Please note: We always install options in the factory. Retrofitting is not possible.

	COMPACT	STANDARD	STANDARD S
Horizontal separation of the frame		○	○
Cutting height limitation Y-axis	○	○	○
Comfort package			○
Laser indicator for horizontal cuts			○
Pneumatically braked support rollers		○	
Mechanically braked support rollers	○		
Small parts support wood		○	○
Grooving device NVV			○
Motor 2-speed 4kW (incl. ProLock Easy-Fix)			○
Special tension	○	○	○
Tropical insulation	○	○	○
Operating hour counter		○	○

## GROOVING DEVICE NVV

INDIVIDUALLY SAW, SHAPE AND DESIGN

Composite panels are a contemporary material for modern architecture, in transport, in trade fair and shop construction as well as for displays.

And they can be easily processed on any Striebig.

The routing and folding technique enables the simple production of moulded parts. Carbide insert profile cutters mill V-shaped and U-shaped grooves on the back of the panels.

The aluminium cover sheet on the front and part of the plastic core remain in place. As the remaining material is so thin, it can be folded 'by hand'. The groove shape determines the bending radius.

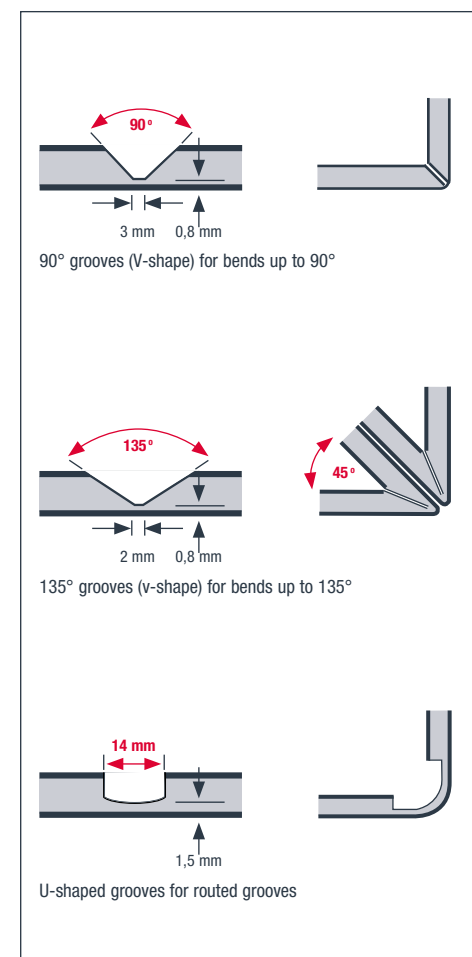

Groove options for composite panels



## LASER INDICATOR

Pin-point accuracy. Laser-supported horizontal cut indicator.





# OPTIONS

## FOR OUR AUTOMATIC SAWS

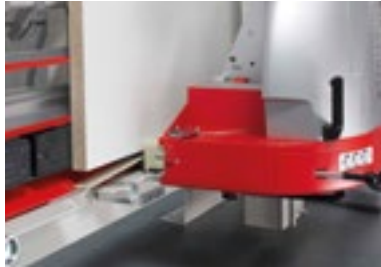

### 4SB - LOWER TRIMMING

The lower trim cut becomes child's play: Panels up to 5300 mm long and 2185 mm high can be trimmed automatically by the 4SB system. This eliminates the need for heavy physical work.



### EPS.x - VERTICAL CUTTING AT YOUR FINGERTIPS

Simply tap the position for the vertical cut on the 12" touch screen panel of the corresponding saw. Finished!



### EXTENDED CUTTING DEPTH

More and more materials demand a greater cut depth.

With EVOLUTION, CONTROL and STRIEBIG 4D, the cutting depth can optionally be extended up to 130 mm.

	EVOLUTION	CONTROL	STRIEBIG 4D
Horizontal separation of the frame	○	○	○
Cutting height limitation Y-axis	○	○	○
Additional EPS.y limited room height		○	
Extended cutting depth 100 mm	○	○	
Extended cutting depth 105 mm			○
Extended cutting depth 130 mm			○
Panel lowering device PAV			○
Programmable panel slide PPS			○
Automatic saw beam positioning ASP			○
Network connection	○		○
Label printer			○
Automatic lower trimming, 4SB		○	
Electronic positioning system EPS.x		○	○
Grooving device NVV	○	○	○
Motor 2-speed 4kW (incl. ProLock Easy-Fix)	○	○	○
Saw motor with infinitely variable speed		○	○
Extended feed speed 0.1-25m / min		○	○
Special voltage	○	○	○
Tropical isolation	○	○	○
Safety switch mat			○
Striebig Cutting Optimization BaseCut / ExpertCut		○	
Striebig Cutting Optimisation POP 4D			○

# ACCESSORIES

FOR OUR MANUAL SAWS

With our wide range of accessories, you can expand the application possibilities of your STRIEBIG according to your requirements and wishes.

All accessory components can be ordered directly from the factory and can also be retrofitted by you.

	COMPACT	STANDARD	STANDARD S
ProLock Easy-Fix tool clamping system			○
Digital measuring system DMS, X-axis	○	○	○
Digital measuring system DMS, Y-axis	○	○	
VSA pre-scoring unit (infinitely variable scoring saw)	○		○
VSA pre-scoring unit (scoring saw adjustable with washers)	○		○
Angle cutting unit WSG mm / inch	○	○	○
Paper holder	○	○	○
Complete small parts support (2 parts)	○	○	○
Grooving device NVP	○	○	
Profile milling cutter U-shape (EN 847-1, MAN)	○	○	○
Profile milling cutter 90° (EN 847-1, MAN)	○	○	○
Profile milling cutter 135° (EN 847-1, MAN)	○	○	○
Adjustable grooving tool (EN-847-1, MAN)	○	○	○
Depth stop adjustment groove tool TVN	○	○	
Strip cutting gauge 400 mm	○		
Strip cutting gauge 600 mm	○		
High-end grid made of synthetic materials	○	○	○
Set of program cams	○		
Additional stop below	○		
Complete freestanding support	○	○	○
Seaworthy packaging	○	○	○
Striebig OptiDivide cutting optimisation	○ from year of construction 2004	○ from year of construction 2005	○



**VSA -  
PRE-SCORING UNIT**  
SAVES TIME, MONEY  
AND EFFORT

For larger quantities, low quality level of the panel and veneered solid wood panels, VSA is a must.



**PROLOCK EASY-FIX  
TOOL TENSION SYSTEM**

This quick-change system is simple, robust and precise to use. This greatly reduces the risk of injury when changing tools.



**ADJUSTABLE GROOVING  
TOOL FOR WOOD PANELS**



**PROFILE MILLING CUTTER**



# ACCESSORIES

## FOR OUR AUTOMATIC SAWS



### WSG - ANGLE CUTTING DEVICE

Cut mitres accurately. The WSG angle cutting unit is inserted to the left and right of each vertical cutting point. It is easy and quick to install. Application range: Panels up to 42 mm thick, exact angles from 0° - 46°.



### CENTRAL SUPPORT MADE FROM FIBRE-REINFORCED PLASTICS

'High-end' grid made of fibre-reinforced plastic material offers special protection for particularly sensitive edge materials and post-forming edges.



### SMALL PARTS SUPPORT

The small parts support avoids the tilting of smaller workpieces between the contact strips on the centre position.

	EVOLUTION	CONTROL	STRIEBIG 4D
ProLock Easy-Fix tool clamping system	○	○	
VSA pre-scoring unit (infinitely variable scoring saw)	○	○	○
VSA pre-scoring unit (scoring saw adjustable with washers)	○	○	○
Angle cutting unit WSG mm / inch	○	○	○
Paper holder	○	○	○
Complete small parts support (2 parts)	○	○	○
Profile milling cutter U-shape (EN 847-1, MAN)	○	○	○
Profile milling cutter 90° (EN 847-1, MAN)	○	○	○
Profile milling cutter 135° (EN 847-1, MAN)	○	○	○
Adjustable grooving tool (EN-847-1, MAN)	○	○	○
High-end grid made of synthetic materials	○	○	
Complete freestanding support	○	○	○
Seaworthy packaging	○	○	○
Striebig OptiDivide cutting optimisation	○ from year of construction 2001	○ from year of construction 2001	



### PAPER HOLDER -

DOCUMENTS ALWAYS WITHIN REACH

Keeps the work documents available right beside the control box.

# TECHNICAL DATA

## COMPACT

Type	Dimensions in mm				Cutting range in mm		
	L	H	D1 free	D2 wall	LS	HS vert	HS hor
6220	6506	2980	1466	1441	5350	2200	2100
6207	6506	2838	1428	1428	5350	2070	1958
6164	6506	2400	1391	1391	5350	1644	1532
5220	5826	2980	1466	1441	4600	2200	2100
5207	5826	2838	1428	1428	4600	2070	1958
5164	5826	2400	1391	1391	4600	1644	1532
4220	4256	2980	1466	1441	3100	2200	2100
4207	4256	2838	1428	1428	3100	2070	1958
4164	4256	2400	1391	1391	3100	1644	1532

Weight of the saw	approx 910 kg
Cutting depth	60 mm
Saw motor rating	3,9 kW
Saw blade diameter	250 mm
Saw blade bore	30 mm *1
Emission sound pressure level at the workplace $L_{pA}$	82 dB *2
Saw blade speed	5250 U/min
2 Extraction connection *3	ø 100 mm
Connected load	4,8 kW
Mains connection	3 x 400 V / 50 Hz

\*1 with 2 side holes ø 7 mm, radius 21 mm · \*2 Measurement standards and emission values in accordance with EN 1870-14, measurement uncertainty allowance K = 4 dB(A) · \*3 main extraction on the left or right, extraction wall on the right (fixed). (All details refer to the COMPACT Typ 6220)

## STANDARD - TRK1 / TRK2

Type	Dimensions in mm				Cutting range in mm		
	L	H	D1 free	D2 wall	LS	HS vert	HS hor
6224	6535	2901	1705	1340	5300	2240	2100
6216	6535	2817	1669	1333	5300	2160	2016
6168	6535	2343	1464	1219	5300	1680	1540
5224	5535	2901	1705	1340	4300	2240	2100
5216	5535	2817	1669	1333	4300	2160	2016
5168	5535	2343	1464	1291	4300	1680	1540
4224	4535	2901	1705	1340	3300	2240	2100
4216	4535	2817	1669	1333	3300	2160	2016
4168	4535	2343	1464	1291	3300	1680	1540

Weight of the saw	approx 1.100 kg
Cutting depth	80 mm
Saw motor rating	5,5 kW
Saw blade diameter	300 mm
Saw blade bore	30 mm *1
Emission sound pressure level at the workplace $L_{pA}$	79 dB *2
Saw blade speed	4750 U/min
1 Extraction connection	ø 140 mm
Connected load	7,5 kW
Mains connection	3 x 400 V / 50 Hz

\*1 with 2 side holes ø 9 mm, radius 30 mm · \*2 Measurement standards and emission values in accordance with EN 1870-14, measurement uncertainty allowance K = 4 dB(A). (All details refer to the STANDARD Typ 6224)

## STANDARD S - TRK1 / TRK2

Type	Dimensions in mm				Cutting range in mm		
	L	H	D1 free	D2 wall	LS	HS vert	HS hor
6224	6626	3055	1766	1383	5300	2240	2100
6216	6626	2971	1730	1376	5300	2160	2016
6168	6626	2497	1525	1334	5300	1680	1540
5224	5626	3055	1766	1383	4300	2240	2100
5216	5626	2971	1730	1376	4300	2160	2016
5168	5625	2497	1525	1334	4300	1680	1540
4224	4626	3055	1766	1383	3300	2240	2100
4216	4626	2971	1730	1376	3300	2160	2016
4168	4626	2497	1525	1334	3300	1680	1540

Weight of the saw	approx 1.100 kg
Cutting depth	80 mm
Saw motor rating	5,5 kW
Saw blade diameter	300 mm
Saw blade bore	30 mm *1
Emission sound pressure level at the workplace $L_{pA}$	83 dB *2
Saw blade speed	4800 U/min
1 Extraction connection	ø 140 mm
Compressed air connection *3	6-10 bar
Connected load	7,5 kW
Mains connection	3 x 400 V / 50 Hz

\*1 with 2 side holes ø 9 mm, radius 30 mm · \*2 Measurement standards and emission values in accordance with EN 1870-14, measurement uncertainty allowance K = 4 dB(A) · \*3 Compressed air connection only necessary for options. (All details refer to the STANDARD S Typ 6224).



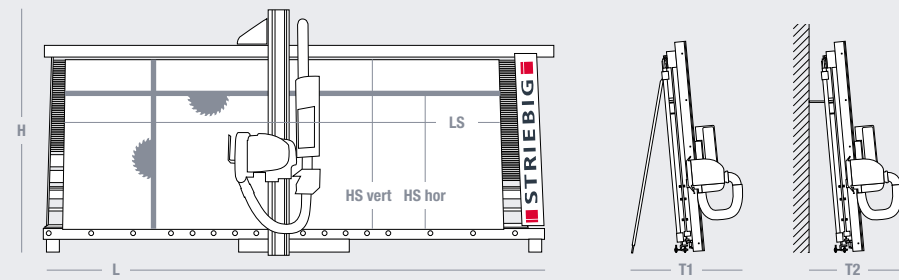

LS = Cutting range  
 HS vert = Cutting range vertical  
 HS hor = Cutting range horizontal

## EVOLUTION

Type	Dimensions in mm				Cutting range in mm		
	L	H	D1 free	D2 wall	LS	HS vert	HS hor
6224	6645	3018	1741	1361	5300	2240	2100
6216	6645	2934	1700	1354	5300	2160	2016
6168	6645	2460	1500	1312	5300	1680	1540
5224	5645	3018	1741	1361	4300	2240	2100
5216	5645	2934	1700	1354	4300	2160	2016
5168	5645	2460	1500	1312	4300	1680	1540
4224	4645	3018	1741	1361	3300	2240	2100
4216	4645	2934	1700	1354	3300	2160	2016
4168	4645	2460	1500	1312	3300	1680	1540

Weight of the saw	approx 1.100 kg
Cutting depth	80 mm *1
Saw motor rating	5,5 kW
Saw blade diameter	300 mm
Saw blade bore	30 mm *2
Emission sound pressure level at the workplace L <sub>pa</sub>	83 dB *3
Saw blade speed	4800 U/min
1 Extraction connection	ø 140 mm
Compressed air connection	6-10 bar
Connected load	7,5 kW
Mains connection	3 x 400 V / 50 Hz

\*1 Option: 100 mm · \*2 with 2 side holes Ø 9 mm, radius 30 mm · \*3 Measurement standards and emission values in accordance with EN 1870-14, measurement uncertainty allowance K = 4 dB(A) (All details refer to the EVOLUTION Typ 6224)

## CONTROL

Type	Dimensions in mm				Cutting range in mm		
	L	H	D1 free	D2 wall	LS	HS vert	HS hor
6224	7153	3035	1741	1361	5300	2240	2100
6216	7153	2951	1700	1354	5300	2160	2016
6168	7153	2477	1500	1312	5300	1680	1540
5224	6153	3035	1741	1361	4300	2240	2100
5216	6153	2951	1700	1354	4300	2160	2016
5168	6153	2477	1500	1312	4300	1680	1540
4224	5153	3035	1741	1361	3300	2240	2100
4216	5153	2951	1700	1354	3300	2160	2016
4168	5153	2477	1500	1312	3300	1680	1540

Weight of the saw	approx 1.200 kg
Cutting depth	80 mm *1
Saw motor rating	5,5 kW
Saw blade diameter	300 mm
Saw blade bore	30 mm *2
Emission sound pressure level at the workplace L <sub>pa</sub>	83 dB *3
Saw blade speed	4800 U/min
1 Extraction connection	ø 140 mm
Compressed air connection	6-10 bar
Connected load	7,5 kW
Mains connection	3 x 400 V / 50 Hz

\*1 Option: 100 mm · \*2 with 2 side holes Ø 9 mm, radius 30 mm · \*3 Measurement standards and emission values in accordance with EN 1870-14, measurement uncertainty allowance K = 4 dB(A). (All details refer to the CONTROL Typ 6224)

## STRIEBIG 4D

Type	Dimensions in mm				Cutting range in mm		
	L	H	D1 free	D2 wall	LS	HS vert	HS hor
6224	7303	3126	2074	1604	5300	2240	2100
						mit PAV	2170
Cutting depth 80 mm							
6224	7463	3241	2192	1868	5300	2240	2100
						mit PAV	2170
Cutting depth 95/130 mm							

Weight of the saw	approx 1.800 kg
Cutting depth	80 mm *1
Saw motor rating	5,5 kW
Saw blade diameter	300 mm *2
Saw blade bore	30 mm *3
Emission sound pressure level at the workplace L <sub>pa</sub>	83 dB *4
Saw blade speed	4800 U/min
1 Extraction connection	ø 140 mm
Compressed air connection	6-10 bar
Connected load	7,5 kW
Mains connection	3 x 400 V / 50 Hz

\*1 Option: bis 130 mm · \*2 Option: bis 400 mm · \*3 with 2 side holes Ø 9 mm, radius 30 mm  
 \*4 Measurement standards and emission values in accordance with EN 1870-14, measurement uncertainty allowance K = 4 dB(A). (All details refer to the Striebig 4D Typ 6224)

**Valid for all saws:** efficient integral TRK dust extraction system, dust limit value below 2mg/m<sup>3</sup>. The system used must have an extraction performance of 20 m<sup>3</sup>/sec. (vacuum approx. 1,400 Pa., COMPACT approx. 1,470 Pa) at the connector in order to meet the TRK specifications.

All technical specifications are approximate values.  
 We reserve the right to amend specifications in accordance with further development.

# VERTICAL SAW TECHNOLOGY

VERSATILE. PRECISE. SOLID.

## Striebig AG

Grossmatte 26  
CH-6014 Luzern

Tel. +41 (0) 41 259 53 53  
Fax +41 (0) 41 259 53 50  
[info@striebig.com](mailto:info@striebig.com)

All technical specifications are approximate values. We reserve the right to amend specifications in accordance with further development.

[www.facebook.com/striebig.ag](http://www.facebook.com/striebig.ag)



■ STRIEBIG ■

[WWW.STRIEBIG.COM](http://WWW.STRIEBIG.COM)